

MMK MML

Horizontal Multistage Ring Section Pump



 **TORISHIMA**

Horizontal Multistage Ring Section Pump

TORISHIMA MMK and MML are horizontal, radially split ring section multistage pumps. The casings are sealed by O-ring and held together by the bolts. The stage casing and the tie bolts are encased in a steel cladding. The pump feet are arranged either foot-mounted or center line mounted according to the number of stages and the temperature.

Applications

- Boiler Feed
- Condensate
- Fire-fighting
- District Installations for Pumping Clean Water
- General Water Supply

Technical Data

Capacity	up to 1,800m ³ /h (7,930USgpm)
Total Head	up to 500m (1,640ft)
Temperature	up to 230°C (446°F)
Max. Pump Suction Pressure	up to 30bar (435psi)
Max. Pump Discharge Pressure	up to 54bar (783psi)
Speed	up to 3,600min ⁻¹
Size	DN 40 to 250mm (1 ² / ₃ to 10")

Materials

The followings are used for standard material combinations:

Suction, discharge and stuffing box casing	Cast iron, Bronze, Cast seel, Ductile iron
Stage casing	Cast iron, Bronze, Cast seel, Ductile iron
Impellers, and diffusers	Cast iron, Bronze, Stainless steel
Shaft	Carbon steel, Stainless steel
Balance disc/seat	Cast iron, 13%Cr cast steel, 18%Cr cast steel,
Casing wear ring	Cast iron, Bronze, 2.5%Ni cast iron

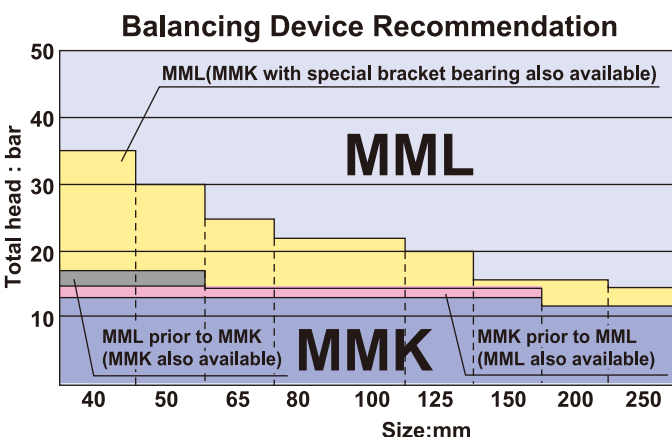

Booster pumps in water supply system of buildings



Boiler feed pumps in district heating and cooling plant



Distributing pumps in small-capacity water works



Fire-fighting pump

Flexible Design to Meet Your Application Requirements

Bearing Options

- MMK—A roller bearings at the suction end, and a ball bearing at the discharge end
- MML—Roller bearings on both ends
- All bearing fitted with oil level indicator as standard

Flexible nozzle design

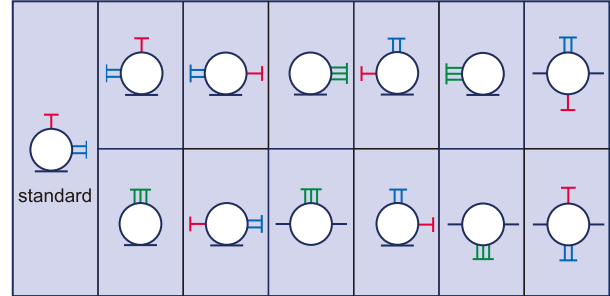

Nozzle orientation viewed from driver side
 T :Suction, T :Discharge, — :Foot

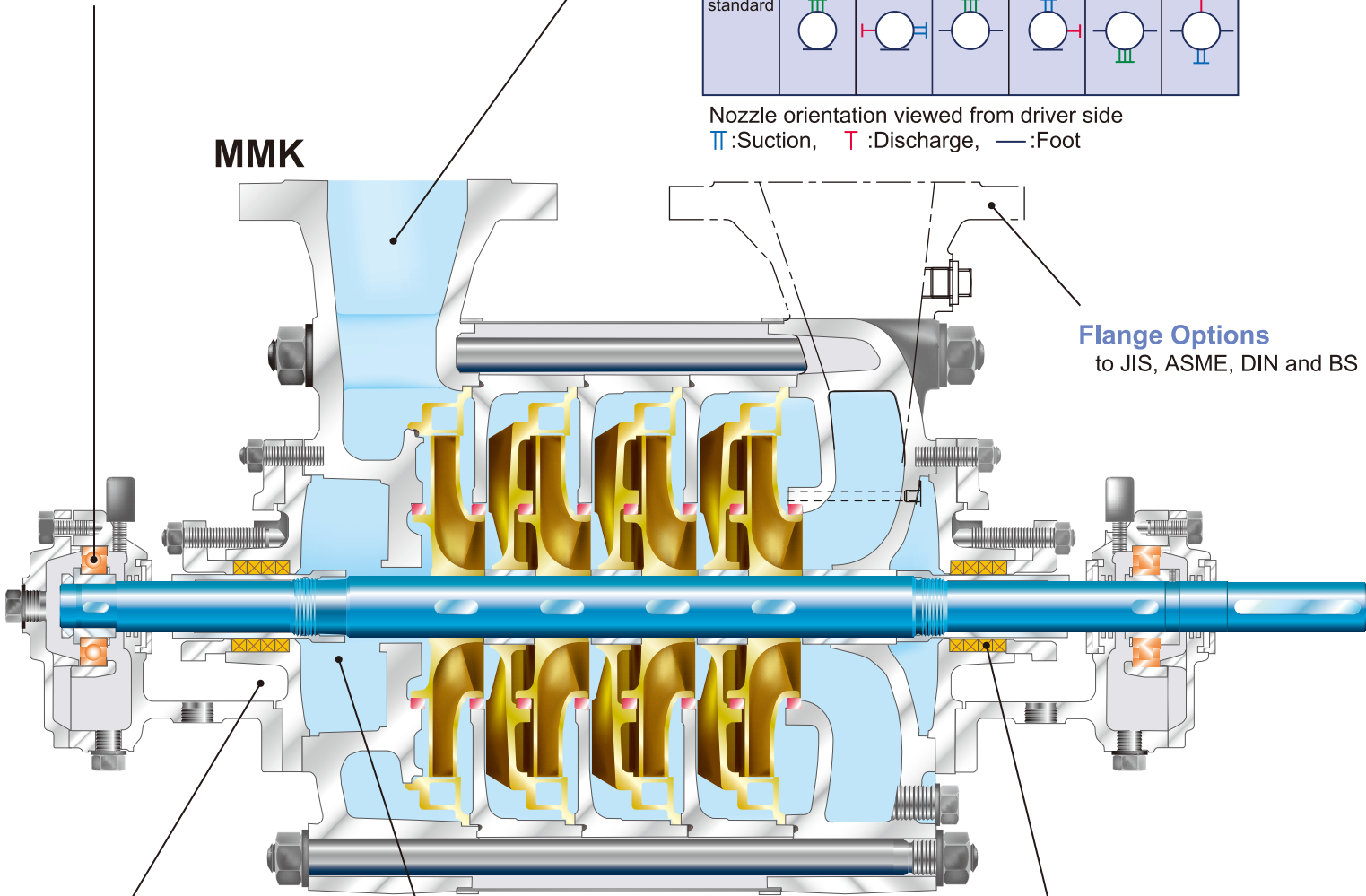

Stuffing Box Options

- designed to suit pumped fluid
- Cooled
- Uncooled

Balancing Device Options

- MMK—Deep groove or angular contact ball bearings+balance holes in impellers
- MML—Balance disk and balance seat

Shaft Seal Options

- Gland packing
- Mechanical seal

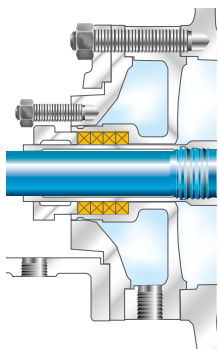

Cooled stuffing box

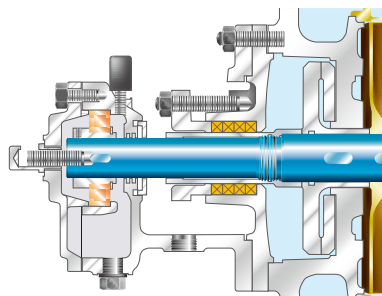

MML—Balance disk and seat

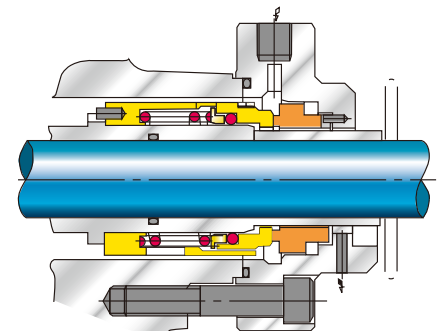

Single acting balanced mechanical seal
 Type:HB2700BNUH

Performance Range

On MML pumps, the minimum delivery pressure should not be allowed to drop below 12.7bar(184psi) to maintain balance device clearance.

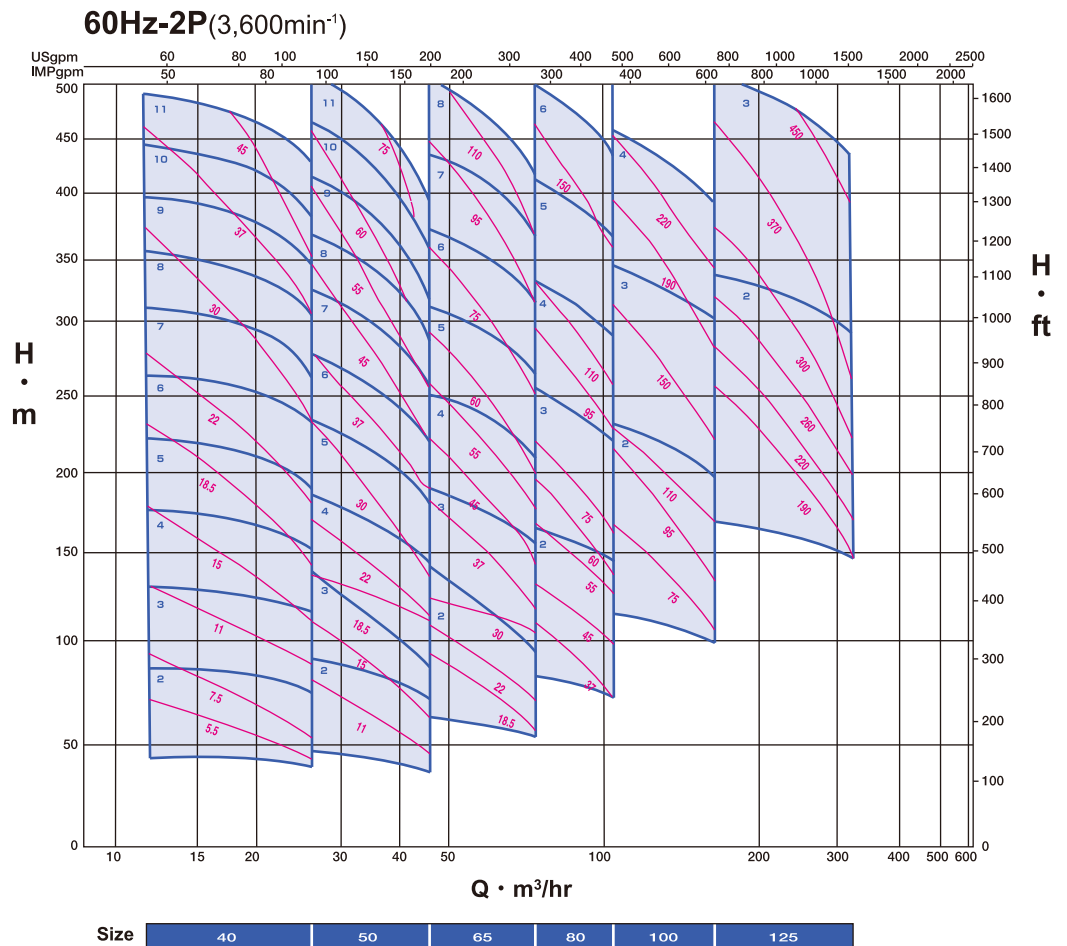
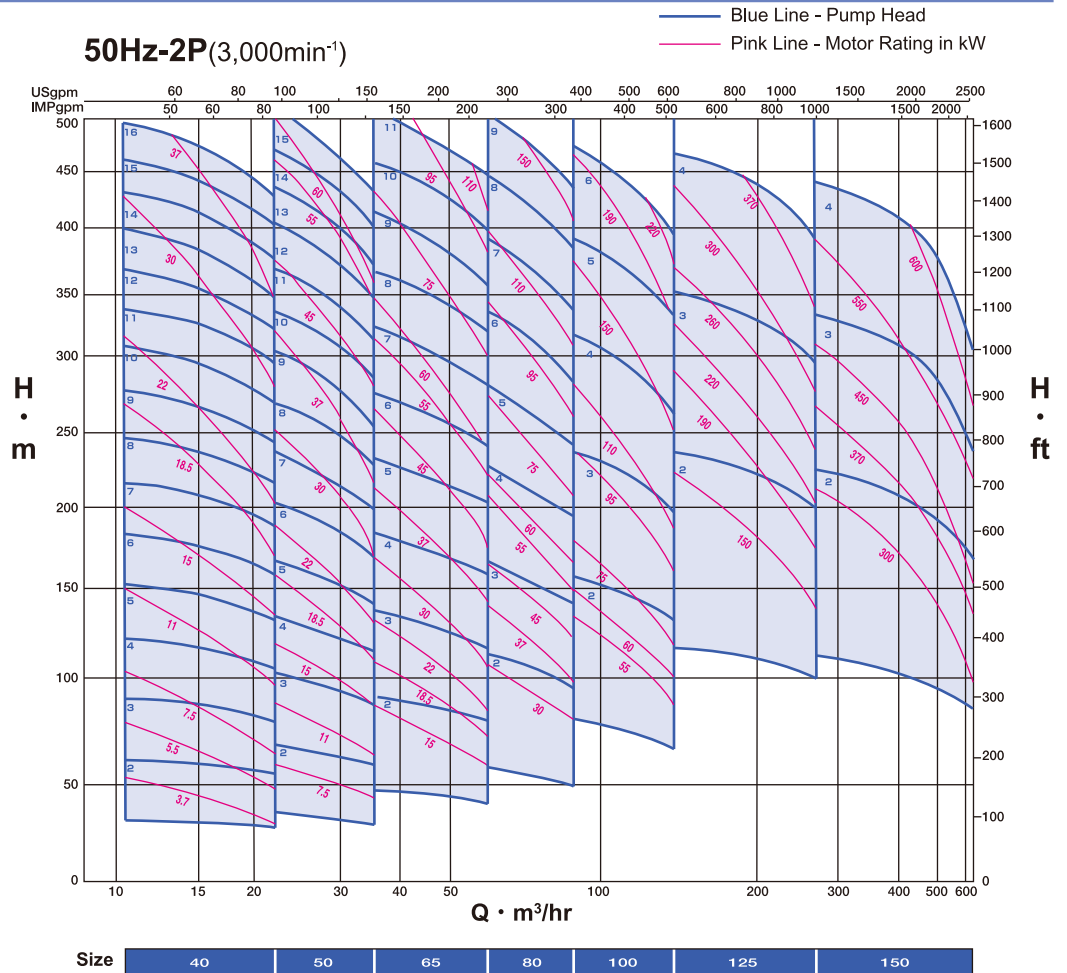

50Hz-4P(1,500min⁻¹)

Blue Line - Pump Head
Pink Line - Motor Rating in kW

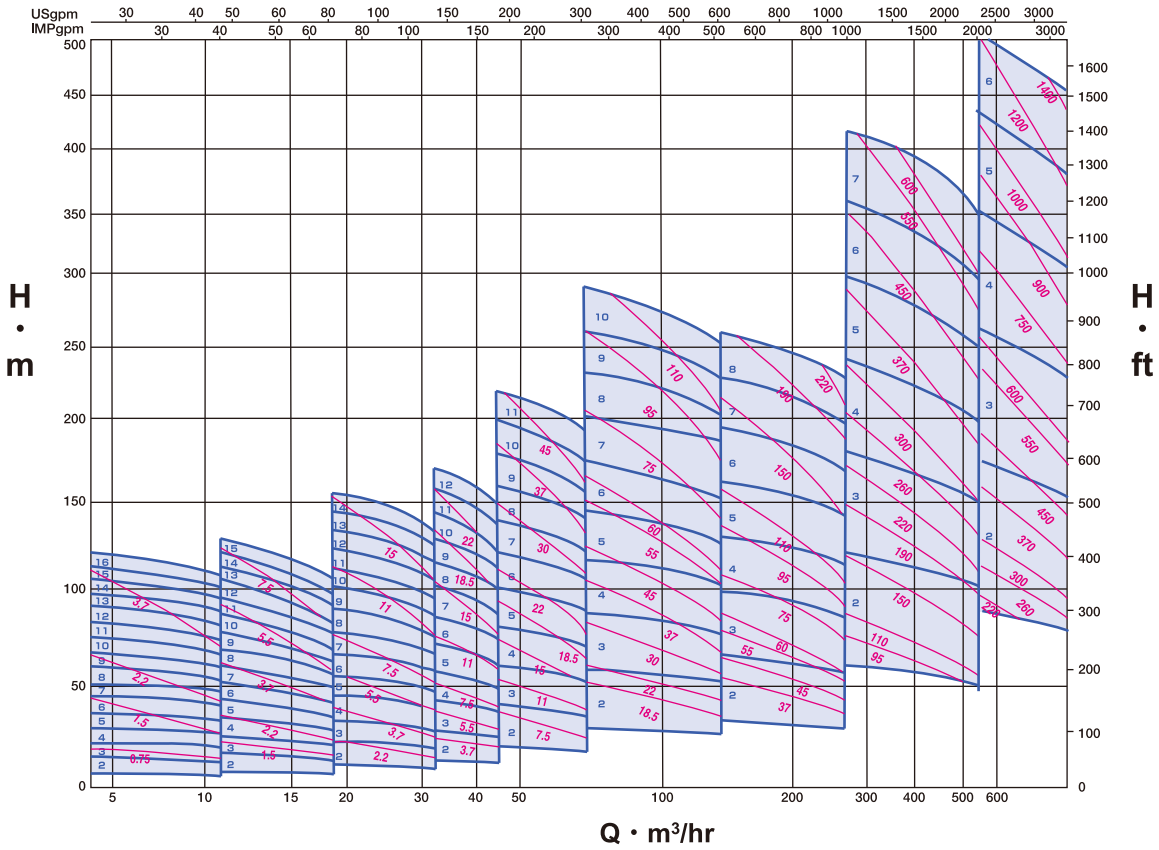

Size	40	50	65	80	100	125	150	200	250
------	----	----	----	----	-----	-----	-----	-----	-----

60Hz-4P(1,800min⁻¹)

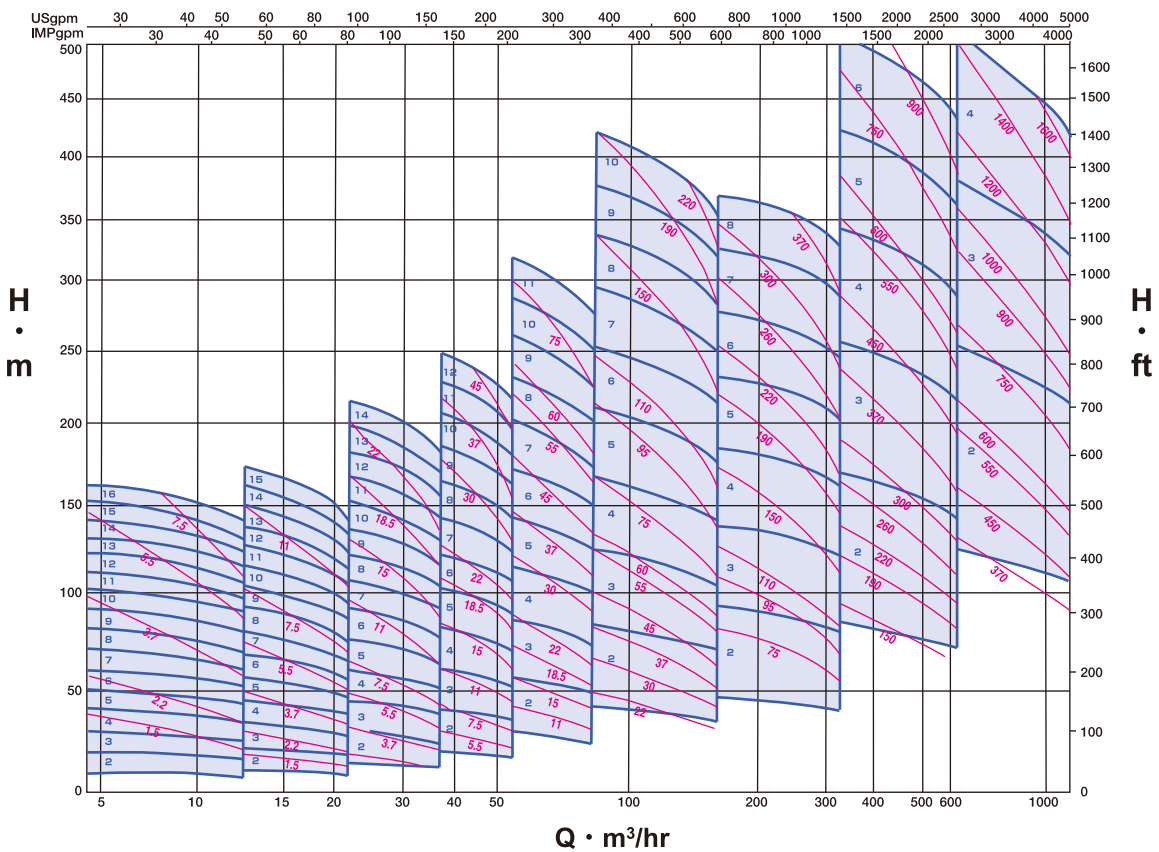

Size	40	50	65	80	100	125	150	200	250
------	----	----	----	----	-----	-----	-----	-----	-----

Torishima Pump Global Network



JAPAN

① Torishima Pump Mfg. Co., Ltd.



1-1-8 Miyata-cho, Takatsuki-city, Osaka 569-8660 Japan
Tel : +81-72-690-2308 / Fax : +81-72-690-2329

② Kyushu Torishima Co., Ltd.



9857-13, Ohaza Kawako, Wakagi-cho, Takeo-city,
Saga 840-0813 Japan
Tel : +81-954-26-3081 / Fax : +81-954-26-3080

CHINA

③ Torishima Pump Mfg. Co., Ltd.

Beijing Office ■■■

Rm707, Building 1, KUNSHA CENTER,
No.16 Xinyuanli, Chaoyang District,
Beijing, P.R.China PC:100027
Tel : +86-10-84682891 / Fax : +86-10-84682890

④ Torishima Pump (Tianjin) Co., Ltd.



No.9 Gaixin Road, Wuqing Development Zone,
Tianjin.China P.R.
Tel : +86-22-59695601 / Fax : +86-22-59695609

HONG KONG

⑤ Torishima (Hong Kong) Ltd. ■■■

Unit A, 21/F., Tower A, Billion Centre, 1 Wang Kwong
Road, Kowloon Bay, Kowloon, Hong Kong
Tel : +852-2795-1838 / Fax : +852-2754-3293

VIETNAM

⑥ Torishima (Hong Kong) Ltd.

Vietnam Office ■■■

No.76 Bui Thi Xuan Street, Hai Ba Trung District,
Hanoi, Socialist Republic of Vietnam
Tel : +84-4-943-7880 / Fax : +84-4-943-7876

SINGAPORE

⑦ Torishima Pump Mfg. Co., Ltd.

Singapore Office ■■■

30 Ubi Crescent #01-02 Ubi Techpark,
Singapore 408566
Tel : +65-6779-0123 / Fax : +65-6779-6900

⑧ Torishima Service Solutions Asia Pte. Ltd.



48, Toh Guan Road East, #02-142,
Enterprise Hub, Singapore 608586
TEL : +65-6933-8772 / FAX : +65-6933-8777

INDONESIA

⑨ P.T. Torishima Guna Engineering



Jalan Rawa Sumur Timur No.1 Pulogadung
Industrial Estate, P.O.Box 1160, Jakarta, Indonesia
Tel : +62-21-460-3963 / Fax : +62-21-460-3937

⑩ P.T. Torishima Guna Indonesia ■■■

Jalan Rawa Sumur Timur No.1 Pulogadung
Industrial Estate, P.O.Box 1160, Jakarta, Indonesia
Tel : +62-21-460-3963 / Fax : +62-21-460-3937

⑪ P.T. Geteka Founindo ■

JL Pulo Ayang Kav. AA2 Pulogadung Industrial Estate,
P.O.Box 1160 JAT, Jakarta 13011 Indonesia
Tel : +62-21-460-3963 / Fax : +62-21-460-3937

INDIA

⑫ Torishima Pumps India Pvt. Ltd. ■■■

Tower B 1106, Millennium Tower, Sector27
Gurgaon-122002, Haryana, India
Tel : +91-124-4728950 / Fax : +91-124-4728950

AUSTRALIA

⑬ Torishima Australia Pty. Ltd. ■■■

52 Reid Street, Murrumbena, Victoria, Australia 3163
Tel : +61-434-709172

U.A.E.

⑭ Torishima Service Solutions FZCO



Plot of Land TP010501 Techno Park-Jebel Ali,
PO Box. 37603 Dubai, U.A.E.
Tel : +971-4-880-7344 / Fax : +971-4-880-7354

⑮ Torishima Pump Mfg. Co., Ltd.

Middle East Office ■■

Office No.901, Deluxe Tower, Delma Street,
Al Nahyan Camp Area, P.O.Box 53567,
Abu Dhabi, U.A.E.
Tel : +971-2-674-3880 / Fax : +971-2-674-3881

QATAR

⑯ Torishima Pump Mfg. Co., Ltd.

Qatar Project Office ■■

Office No.11,1st Floor, West Corner Centre,
Salwa Road-Midmac R/A, P.O.Box 37027 Doha, Qatar
Tel : +974-4450-6915 / Fax : +974-4450-6916

U.K.

⑰ Torishima Europe Ltd. ■■

Sunnyside Works, Gartsherrie Rd, Coatbridge,
Scotland ML5 2DJ
Tel : +44-1236-443951 / Fax : +44-1236-702875

⑱ Torishima Service Solutions Europe Ltd.



Sunnyside Works, Gartsherrie Rd, Coatbridge,
Scotland ML5 2DJ
Tel : +44-1236-442390 / Fax : +44-1236-702875

⑲ Torishima Europe Projects Ltd. ■

Hartham Park, Corsham, Wiltshire,
England SN13 0RP
Tel : +44-1249-700-290

SPAIN

⑳ Torishima Europe Ltd. Madrid Office ■■

Avda, Fuente Nueva 12A Edif, Monterrey, 28703
San Sebastian de los Reyes, Madrid, Spain
Tel : +34-91-284-6909 / Fax : +34-91-284-6901

U.S.A.

㉑ Torishima Pump Mfg. Co., Ltd.

U.S. Office ■■■

100 Grove Street, Suite 217, Worcester
MA 01605-2654 U.S.A.
Tel : +1-508-753-6600 / Fax : +1-508-753-8276

CANADA

㉒ Torishima Services Canada Inc. ■■

Suite 2800, 350-7th Ave S.W.
Calgary, Alberta T2P 3N9, Canada
Tel : +1-403-705-1933

